

► INTERIOR FITTING

FEIN. Unverwüstliche  
Elektrowerkzeuge.



**The quality and versatility leader.  
For more than 40 years.**

FEIN MULTIMASTER. The universal system for interior fitting and renovation.



## **FEIN MULTIMASTER – the benchmark for professional working at the highest standard.**

As the inventor of the first electric hand drill and as the oldest manufacturer of power tools in the world, FEIN has unique know-how in the power tools industry. FEIN also has 40 years of experience in oscillation technology. This knowledge and our extensive experience is embodied in the FEIN MULTIMASTER and the tailored accessories.

The unbeatably versatile and completely reliable all-rounder is the leading tool for interior fitting and renovation work – no other oscillator can be used in such a wide range of applications.



**Innovative and solution-oriented.**

Work to continuously further develop and match the FEIN MULTIMASTER and its accessories to new applications is ongoing. The round backing pad, which was exclusively developed for the FEIN MULTIMASTER, makes applications such as sanding medium-sized and large surfaces child's play. It features outstanding sanding capacity, delivers perfect surface results and even allows you to sand near edges without kick-back – which means you don't even have to use an additional random sander.

**The FEIN MULTIMASTER Pages 4–7**



With the FEIN MULTIMASTER, FEIN has developed a power tool that offers impressive quality and reliability. It is designed for maximum loading and outstanding work progress. It is truly durable– and indispensable in renovation, interior fitting and hobby work.

**Renovation Pages 8–9**



The FEIN MULTIMASTER works flush to the surface. It allows you to saw off protruding nails, screws, pipes or even door frames flush to the surface and to fit laminate or skirting boards with millimetre precision

**Interior fitting Pages 10–15**



No matter whether you want to renovate windows, replace tiles, lay flooring or restore furniture, the FEIN MULTIMASTER accomplishes even time-consuming work with ease and precision.

**Hobbies Pages 16–19**



The FEIN MULTIMASTER allows you to accomplish all hobby work cleanly and at speed. No matter whether you're building models, tending to your home or garden or repairing and maintaining boats – you're extremely well equipped with the FEIN MULTIMASTER.

**Accessories Pages 20–23**



The FEIN MULTIMASTER is a complete system. Outstanding quality, a long service life and an extensive range of accessories enable you to accomplish a wide range of applications you didn't think were even possible.



## Sophisticated technology – lasting quality.

### Universal suitability.

The oscillating motion of the FEIN MULTIMASTER, which makes it a truly universal tool, is suited to countless applications that would otherwise require a great deal of effort and time. Its extremely durable transmission and the oscillating motion ensure an outstanding working speed in all applications such as sawing, sanding, cutting, separating, scraping and polishing on virtually all materials.

### Smooth

- ▶ State-of-the-art production technology for a perfectly balanced armature
- ▶ Ball bearings on both sides for extremely smooth running

### Durable

- ▶ All transmission parts made from metal and designed for maximum loading and an extremely long service life
- ▶ Only high-quality ball and needle roller bearings are used
- ▶ Drive fork made from precision casting
- ▶ Drive shaft made from tempered tool steel

### Long-life

- ▶ Metal transmission head made from high-quality aluminium alloy
- ▶ Transmission parts in extremely secure position
- ▶ Not sensitive to extreme mechanical loading
- ▶ Stable mechanical interface for stationary use in the drill jig or for attaching a depth stop

### Comfortable

- ▶ Patented, tool-free QuickIN quick clamping system for fast and easy tool changes
- ▶ 100% power transmission
- ▶ Tools are secured in a precisely fitted position
- ▶ Accessories can be rotated by 45° eight times

### Sophisticated



- ▶ Amplitude of  $2 \times 1.6$  degrees
- ▶ Up to 20,000 oscillations per minute.
- ▶ Continuously variable cutting frequency
- ▶ Perfectly smooth running for sanding and rasping – even in corners and around edges

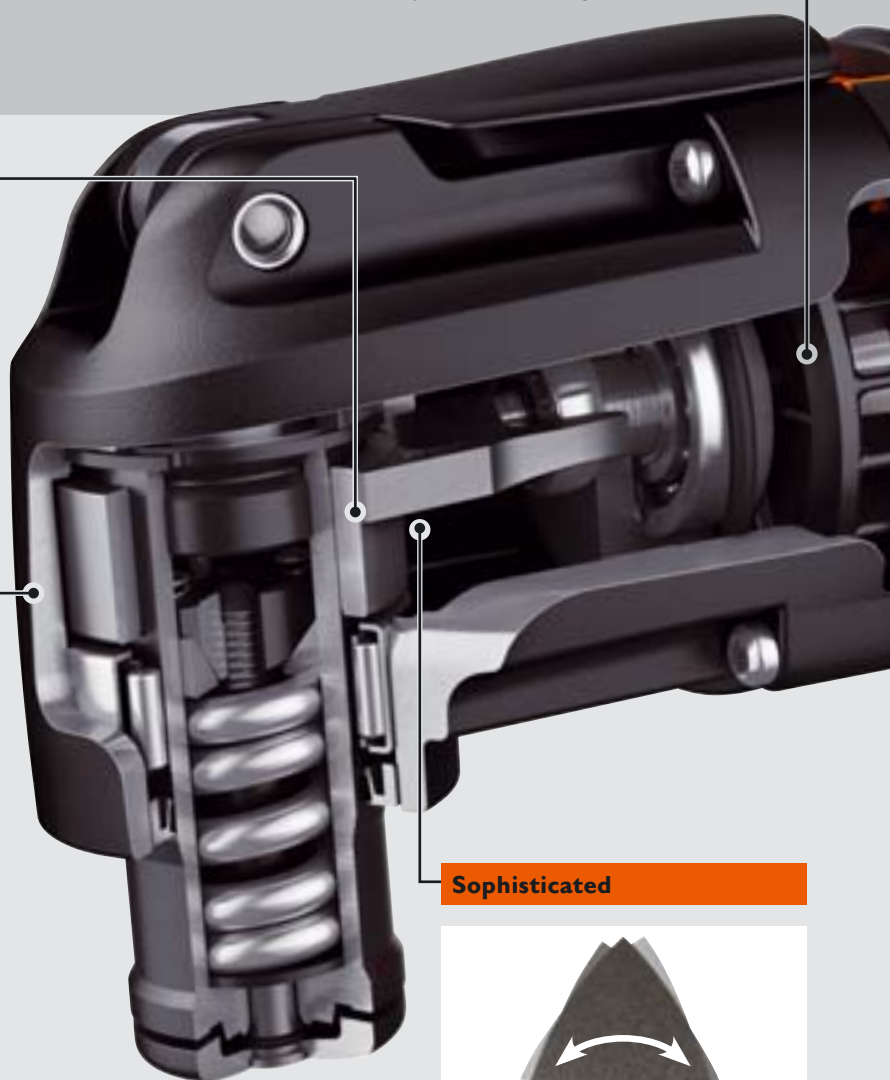



**Easy-to-use**

- ▶ Award-winning ergonomics
- ▶ Fatigue-free working
- ▶ Soft grip zone in the handle area for optimum handling

**Resistant**

- ▶ Armature with welded collector terminals
- ▶ Good temperature resistance even under extreme loads
- ▶ Armature coil and field coil reliably and permanently protected from aggressive dusts thanks to special seal

**Reliable**

- ▶ Electronics completely sealed
- ▶ Resistant to dirt
- ▶ Not sensitive to vibrations

**Practical**

- ▶ Finely stranded rubber cable of industrial quality
- ▶ Suited to maximum loading even adverse conditions on the construction site
- ▶ Optimum mobility at all temperatures
- ▶ 5 m cable length for large working radius

**Robust**

- ▶ Polyamide motor housing with high glass fibre content, resistant to shock and impact
- ▶ Barrel design for maximum stability and distortion rigidity
- ▶ Field coil and armature fully shielded by motor housing for secure bearing seat for rotating parts

**Powerful**

- ▶ FEIN high-power motor
- ▶ Suited to continuous use and overload
- ▶ Maximum performance thanks to high copper content

**Technical data**

Model		FMM 250	FMM 250 Q
Power	W	250	
Oscillations	rpm	11,000 – 20,000	
Cable	m	5	
Sanding pad above corner	mm	80	
QuickIN tool holder		-	●

Emission values (sound/vibration) can be found at [www.fein.com](http://www.fein.com)

## A perfect match for every need: the FEIN MULTIMASTER sets.

The FEIN MULTIMASTER system is perfectly matched to the everyday requirements and needs of its users – with an extensive range of accessories for all professional applications in interior fittings, renovation and repairs. You can choose between four different FEIN MULTIMASTER sets, which are graded according to their range of accessories and capacity – from a basic programme up to a complete set including dust extraction.

### FEIN MULTIMASTER START



The universal system for interior fitting and renovation featuring basic equipment for the most common applications.

### FEIN MULTIMASTER SELECT PLUS



The universal system for interior fitting and renovation features an extensive selection of accessories for a wide range of applications.

### FEIN MULTIMASTER TOP PLUS





















The universal system for interior fitting and renovation features unique equipment including a comprehensive range of sanding accessories for a huge number of different applications.

### FEIN MULTIMASTER TOP EXTRA



How can you improve the FEIN MULTIMASTER TOP PLUS set? By providing a clean workplace along with it. Including the versatile dust extractor FEIN DUSTEX 25.

## FEIN MULTIMASTER sets

Scope of supply	START	SELECT PLUS	TOP PLUS	TOP EXTRA
				
1 FEIN MULTIMASTER FMM 250	▲	-	-	-
 1 FEIN MULTIMASTER FMM 250 Q / Quick IN	-	▲	▲	▲
1 sanding pad, unperforated, sanding sheets, 5 of each grit (60, 80, 120, 180), unperforated	▲	▲	▲	▲
 1 E-CUT universal saw blade, bi-metal teeth, 44mm wide	▲	▲	▲	▲
 1 rigid stopper knife	▲	▲	▲	▲
 1 E-CUT standard saw blade, 65 mm wide	-	▲	▲	▲
 1 carbide segment saw blade, Ø 63 mm	-	▲	▲	▲
 1 carbide rasp	-	▲	▲	▲
 1 HSS segment saw blade, Ø 80 mm	-	▲	▲	▲
 1 M-CUT saw blade, 30 mm wide	-	-	▲	▲
 1 round backing pad, Ø 115 mm, perforated, sanding sheets, 2 of each grit (60, 80, 180), perforated	-	-	▲	▲
 1 sanding pad, perforated, sanding sheets, 5 of each grit (60, 80, 120, 180), perforated	-	-	▲	▲
 1 dust extraction device, incl. 2 hose sockets, Ø 27 and 32 mm, 2 adapters for household vacuum cleaners	-	-	▲	▲
 1 profile sanding set incl. 6 profile inserts, sanding sheets, 5 of each grit (80, 120, 180)	-	-	▲	▲
 1 plastic tool case with interior partitions for safe storage and transport	-	▲	▲	▲
 1 FEIN DUSTEX 25 dust extractor with automatic switch-on and extensive accessories	-	-	-	▲
				
<b>Order number</b>	<b>7 229 36</b>	<b>7 229 37 50</b>	<b>7 229 37 51</b>	<b>7 229 37 52</b>

## The reliable choice for windows and the leading choice for doors.

Windows, garage doors and outdoor installations can be renovated to perfection with the FEIN MULTIMASTER. Grit 40 or 60 can be used to roughly sand windows. In a second work step, the surface is smoothed with grit 150 or 180 – allowing you to achieve outstanding results in a very short space of time. For severely weathered surfaces, it is best to use the round backing pad first, so you work at a much faster pace. Corners are then sanded with the triangular sanding pad. Even brittle putty can be removed with ease and without the risk of glass breakage. The result is a completely renovated window in an astonishingly short space of time.

### Sanding down windows and doors



The round backing pad enables accurate sanding on edges and folds without kick-back.

Order number  
6 38 06 195 02 0

### Sanding gaps and profiles



The flat sanding pad allows you to reach into even tight gaps such as the slats of window shutters.

Order number  
6 38 06 142 02 9

### Sanding down garage doors



FEIN is extending the FEIN MULTIMASTER's range of possible applications to include something new: surface sanding. Thanks to the new round backing pad, it is now possible to sand even larger surfaces cost-effectively and at speed – with a sanding capacity that is considerably superior to most standard random sanders. This means that in most cases, there's no need for a random sander.

Order number  
6 38 06 195 02 0

### Dust-free sanding



For extremely clean results, use the dust extractor for dust-free working.

**Sanding** accessories can be found on pages 21 and 22.

### Sanding and polishing stone window sills



Natural or plastic window sills can be optimally machined with the special range of sanding materials and the felt polishing pad.

Order number  
6 38 06 129 06 7



### Sanding down signs of weathering



The carbide rasp can be used to thoroughly remove even the most stubborn signs of weathering at speed thanks to the high sanding capacity.

Order number  
6 37 31 001 01 4

### Working right into the corners



The HSS segment saw blade can be used to perfectly renovate old windows and allows you to work fatigue-free right into corners without the need for time-consuming rework.

Order number  
6 35 02 106 01 5

### Sanding profiles



The FEIN MULTIMASTER with profile sanding set is ideal for sanding garage doors, tongue and groove boards and other concave or convex profiles.

Order number  
6 38 06 183 01 3

### Removing glass and putty



Brittle putty can be removed with ease and without the risk of glass breakage using the HSS segment saw blade.

Order number  
6 35 02 106 01 5

### Clean working with the FEIN DUSTEX 25

Sanding produces a great deal of dust which accumulates as a fine film on nearby surfaces and in groves and corners, and removing it can be very time-consuming. The FEIN DUSTEX 25 stops dust from being created in the first place and therefore minimises the need for laborious cleaning work. An integrated automatic switch-on function enables the dust extractor to be controlled comfortably using the FEIN MULTIMASTER. More information about the FEIN DUSTEX 25 set can be found on page 23.

Order number  
9 20 22



## The FEIN MULTIMASTER can do everything when it comes to interior work.

Nothing can replace the MULTIMASTER for interior work. No matter whether you want to restore your attic, install a partition or hide the cables of your stereo system behind the wall, the FEIN MULTIMASTER is the perfect tool for all repair and installation work. Even in tight spaces, the FEIN MULTIMASTER saws with precision in recesses and corners and removes a great deal of material when sanding. It allows you to work at speed and with little effort.

### Cutting cable ducts



The M-CUT saw blades can be used to make very fine cut-outs and recesses. The saw blades are suited to virtually all materials such as wood, hard wood, plastics, fibreglass and sheet metals up to 1 mm.

Order number  
6 35 02 159 01 0

The complete range of sawing accessories and attractive savings packages can be found in the Accessories section on pages 20 and 21.

### Cutting cable ducts



The E-CUT standard saw blade is ideal for cutting plastic construction elements such as cable ducts, exhaust air pipes or downpipes.

Order number  
6 35 02 133 01 7

### Making cut-outs in construction wood



The depth stop can be used to set the cutting depth of all E-CUT saw blades and the HSS saw blade for wood in a continuously variable manner.

Order number  
3 26 07 065 01 0

### Cutting and adapting plasterboard



The E-CUT saw blades make light work of cutting plasterboard panels and making cut-outs for electrical installations and so on in ready-fitted panels.

Order number  
6 35 02 133 01 7



**Sawing pipes flush to the wall**



Ideal for dismantling installations that are no longer required. The E-CUT universal saw blades can be used to cut off pipes flush to the wall for subsequent filling.

Order number  
6 35 02 151 01 8

**Sanding down plaster**



Using the carbide rasp to sand down plaster, cement, concrete or tile adhesive eliminates the need for time-consuming and laborious manual work.

Order number  
6 37 31 001 01 4

**Sawing shadow joints**



The HSS saw blade for wood transforms the FEIN MULTI-MASTER into a “mini circular saw” which is ideal for long, precise cuts such as expansion joints in parquet and laminate. Can be used with or without depth stop.

Order number  
3 26 07 065 02 0

**Sanding surfaces**



Would you like to sand medium-sized and large surfaces? The new backing pad makes light work of the job. It guarantees a high sanding capacity and outstanding surface results.

Order number  
6 38 06 195 02 0

## Precision guaranteed – even in tight spaces.

Would you like to assemble and restore furniture like a professional? With the FEIN MULTIMASTER you have the ideal tool for assembling fitted kitchens and furniture. Even difficult work steps, such as sawing recesses in ready-fitted elements, can be performed with ease and precision in very tight spaces. If you're restoring furniture, the FEIN MULTIMASTER can also handle applications such as profile sanding, which was previously a time-consuming manual task, much faster and more efficiently.



### Recesses for cable and pipe entries



The E-CUT saw blades can be used to make space for cable entries, sockets and water connections in cupboards and shelf units without the need for laborious dismantling.

Order number  
6 35 02 151 01 8

### Sanding profiles



The removable inserts of the profile sanding set can be used to comfortably sand in tight spaces, in grooves and on profiles with a much higher sanding capacity.

Order number  
6 38 06 183 01 3

### Fitting and adapting worktops



The E-CUT saw blades can easily saw recesses for subsequent installations and conversions, even if worktops have already been fitted.

Order number  
6 35 02 134 01 5

### Restoring furniture



The FEIN MULTIMASTER is excellently suited to restoring furniture. The round backing pad provides a high sanding capacity and can be used with or without the dust extraction device.

Order number  
6 38 06 195 02 0

### Restoring upholstered furniture



The stepped HSS saw blade saves your effort and upholstery, as staples can be removed with ease and do not have to be pulled out with pliers.

Order number  
6 35 02 144 01 4

### Making subsequent cut-outs



When used in conjunction with the depth stop, the HSS saw blade for wood is ideal for making subsequent cut-outs in laid parquet or laminate flooring.

Order number  
3 26 07 065 02 0

# Restoring all aspects of flooring in an extremely short space of time.

Perfect for work on floor coverings. The FEIN MULTIMASTER covers the entire range of applications when it comes to flooring – from the effortless removal of old coverings such as carpet or PVC and precise cutting of parquet, laminate, skirting boards and door frames to precise sanding of parquet in difficult corners and on edges. With its range of accessories, which were specially developed for the individual applications, and comfortable handling, the FEIN MULTIMASTER saves a great deal of time and effort in all work steps.



## Cutting floor coverings



The convex segment blade can be used to cut even rigid materials such as plastic or carpet with ease.

Order number  
6 39 03 192 01 4

## Cutting parquet and laminate



No matter whether you're working with parquet, laminate or composite materials, the E-CUT universal saw blade allows you to cut everything with precision and in a manner that is adapted to the material.

Order number  
6 35 02 151 01 8

## Removing floor coverings / adhesive residue



Carpet adhesive residue, coatings or other stubborn materials don't stand a chance against the rigid stopper knife.

Order number  
6 39 03 178 01 7

## Sanding down parquet



The FEIN MULTIMASTER and its sanding equipment offer an impressively high sanding capacity and uniform results in places that other tools can't reach.

**Sanding** accessories can be found on pages 21 and 22

## Adjusting door frames with precision



The E-CUT precision saw blades offer an impressively high level of accuracy and cutting speed when adjusting door frames to higher floor coverings and making recesses in parquet and laminate.

Order number  
6 35 02 127 01 7

## Sawing out skirting boards



Now you can saw out fitted skirting boards without damaging the wall and floor. And there's no need for time-consuming rework.

Order number  
6 36 02 152 01 0

## The fast way to clean results in the bathroom.

Renovate bathrooms and kitchens cost-effectively and at speed. The FEIN MULTIMASTER can be used to replace individual damaged tiles without damaging the surrounding ones. With the diamond saw blades or the carbide segment saw blades, the FEIN MULTIMASTER cuts tile joints with extreme precision and produces minimal dust levels. Old tile adhesive can then be removed with ease using the carbide rasp or the stopper knife blade.

### Removing tile joints



The segment saw blade is used to remove damaged tile joints in corners and on edges, as it enables precise working without over-cutting. The segment saw blade is available in carbide or diamond quality. Diamond saw blades offer impressively longer service lives and are also suited to frost-proof joint materials containing epoxy resin used outdoors or to replacing joints.

Order number  
6 35 02 118 01 6 Carbide segment saw blade  
6 35 02 114 01 7 Diamond segment saw blade

### Flush sanding of bases



The carbide rasp is the all-round accessory for tiling. It can be used to flatten tile adhesive, sand tile edges and ensure a flush base.

Order number  
6 37 31 001 01 4

### Removing elastic sealants



The flexible stopper knife is perfect for removing elastic materials such as sealants, residual adhesive or paint – and not just in the bathroom.

Order number  
6 35 03 165 01 3

### Completely removing tile joints



If tile joints need to be removed completely and renewed, the round diamond saw blade is the most cost-effective solution – both in terms of work progress and service life.

Order number  
6 35 02 105 01 2



## Take your workshop to the car.

First-class vehicle repairs. With its wide range of applications – from removing bodywork parts to paint and polishing work – the FEIN MULTIMASTER is ideal for everyone who regularly repairs or renovates cars. It works with extreme precision and requires little effort thanks to its high sanding capacity – which is a major benefit in inaccessible places. Its accessories, which are perfectly matched to the working conditions and materials, make it the ideal tool in the vehicle sector.

### Cutting out bodywork parts



Sheet metals and plastics up to approx. 1 mm thick can be cut burr- and warp-free using the HSS segment saw blades. This results in minimum sparking and avoids laborious rework. They can also be used universally in corner areas.

Order number  
6 35 02 106 01 5

### Repairing sections on the door sill



The round HSS segment saw blades are particularly suited to repairing sections on vehicles damaged in accidents. They can rotate on the drive shaft several times, which considerably extends the service life.

Order number  
6 35 02 097 02 7

### Removing underseal



The rigid stopper knife can also be used to remove underseal and other stubborn coverings in the best possible time.

Order number  
6 39 03 178 01 7

### Sanding down and restoring paint



The FEIN MULTIMASTER is made for applications such as paint errors, defects and areas that would normally be sanded by hand. A high sanding capacity and even sanding pattern are guaranteed.

**Sanding** accessories can be found on pages 21 and 22.



### Making subsequent installations



The MINI CUT and file set can handle tiny cuts from 10 mm with ease – even if they're in hard-to-reach places. Can be used for plastics, metals and wood.

Order number  
6 39 01 025 06 0 Set

### Polishing to a high-gloss finish



The felt polishing pad set brings paint and chrome to a high-gloss finish in no time at all. It also gives a shiny finish to wood and stone.

Order number  
6 38 06 140 02 7 Set

### Restoring aluminium rims



The particularly soft sanding materials from FEIN allow you to work gently but thoroughly. They enable you to machine aluminium rims effectively and perform sensitive paint work.

**Sanding** accessories can be found on pages 21 and 22.

## Take it on board.

Indispensable for use at sea. The FEIN MULTIMASTER offers considerably increased efficiency in boatbuilding and renovation. With a high cutting performance, the FEIN MULTIMASTER works perfectly with wood, fibreglass, carbon fibre-reinforced plastic and virtually all other relevant materials. There is therefore no need for manual work and improvised solutions. It's just as easy to make subsequent installations in tight spaces as it is to satin-finish teak decks.



### Restoring and renovating the deck



The cutter blades can be used to thoroughly remove deck joint materials at speed. The working time for this application is cut by 80%. More time is saved when satin-finishing teak decks.

**Cutting** accessories can be found on page 23.

### Levelling excess material



The rigid stopper knife can be used to cut back excess polyurethane joint materials after jointing at speed and with precision. This saves a lot of time and effort later when it comes to sanding down the teak deck.

Order number  
6 39 03 178 01 7

### Making subsequent installations



The M-CUT saw blade proves itself when subsequently installing electrical or electronic devices. For clean sawing edges without damaging high-quality materials.

Order number  
6 35 02 157 01 0

### Sawing with millimetre precision



Saw with maximum precision, from edge lengths of 10 mm in wood, plastic, fibreglass or sheet metal. Even the smallest recesses can be made with ease and at speed using the M-CUT saw blade.

Order number  
6 35 02 159 01 0

### Filing recesses



Recesses and openings can be deburred and filed to perfection with the carbide file.

Order number  
6 37 06 017 01 0

### Cleaning and polishing



Using the bristle fleece in conjunction with yacht cleaner ensures that fibreglass surfaces with anti-slip structures are cleaned thoroughly.

Order number  
6 37 23 031 01 0

Detailed information about the FEIN MULTIMASTER MARINE and special accessories for virtually all interior fitting, renovation and maintenance work on yachts can be found at [www.fein.com](http://www.fein.com)

# The finishing touch to your home.

Tend to your hobbies, home and garden. No matter whether you're sharpening tools, working with stone and stone products, laying foundations or building models – you're guaranteed to always produce perfect results right down to the smallest detail. The FEIN MULTIMASTER is efficient, precise and is always full of surprises. Its extensive range of system accessories opens up an unimaginable number of applications. Of course, it delivers surprising results in everything it does, thanks to its high cutting and sanding performance, flexible handling and sensitiveness.



## Making cut-outs in model building



The MINICUT and file set is perfect for making small cuts in tight spaces.

Order number  
6 39 01 025 06 0 Set

## Filing in model building



Recesses can be filed with precision using the MINICUT and file set.

Order number  
6 39 01 025 06 0 Set

## Table and drill jig holder



The FEIN MULTIMASTER can be securely clamped into all standard drill jigs using the table and drill jig holder – for extremely precise results. Alternatively, you can also attach the FEIN MULTIMASTER directly to the workbench or work table. This keeps your hands free to guide the work-piece safely.

Order number  
9 26 02 083 01 0

## Sharpening blades / cutters



The MINICUT and file set allows you to sharpen tools in general and garden tools without having to remove the blades in most cases.



Order number  
6 39 01 025 06 0 Set

**FEIN savings packs**  
 Use our multi-packs and enjoy savings.  
 All promotional packs come with up to  
 4 free saw blades!

# The complete FEIN MULTIMASTER range of accessories.

The FEIN MULTIMASTER offers attractive and ideal working results in the most diverse areas of application – from interior fitting, renovation and boatbuilding to automotive repairs. To enable you to perform any job to perfection with the FEIN MULTIMASTER, FEIN also offers an extensive range of accessories that have been specially developed for the various applications and materials.

## Sawing

### HSS saw blade, circular

For plastics, fibreglass, wood, putty, copper/copper alloys and sheet metal up to approx. 1 mm.



Ø mm	Savings Qty pack	Order number
63	1	6 35 02 096 02 3
63	2	6 35 02 096 01 7
63	5 <b>4 + 1</b>	6 35 02 096 05 0
80	1	6 35 02 097 02 7
80	2	6 35 02 097 01 1
80	5 <b>4 + 1</b>	6 35 02 097 05 0

### HSS-segment saw blade

For plastics, fibreglass, wood, putty, copper/copper alloys and sheet metal up to approx. 1 mm. Ideal for working in corners.



Ø mm	Savings Qty pack	Order number
80	1	6 35 02 106 01 5
80	2	6 35 02 106 07 0
80	5 <b>4 + 1</b>	6 35 02 106 08 0

### HSS saw blade, circular, stepped

For plastics, fibreglass, wood, putty, copper/copper alloys and sheet metal up to approx. 1 mm, flush to surface.



Ø mm	Qty	Order number
85	1	6 35 02 144 01 4
85	5	6 35 02 144 02 0

### Segment saw blade, stepped

For soft materials only. Ideal for working in corners, flush to surface.



mm	Order number
84	6 35 02 113 01 9

### Cutting paste

Lubricant for working with sheet metal.

Order number	3 21 32 020 12 9
--------------	------------------

### E-CUT standard saw blade

Saws wood up to 50 mm, plasterboard and soft plastics. Enables simple dipping into the material at any point.

Length 50 mm, form 133



Width mm	Savings Qty pack	Order number
35	1	6 35 02 133 01 7
35	3 <b>2 + 1</b>	6 35 02 133 03 0
35	10 <b>6 + 4</b>	6 35 02 133 04 0

Length 50 mm, form 134



Width mm	Savings Qty pack	Order number
65	1	6 35 02 134 01 5
65	3 <b>2 + 1</b>	6 35 02 134 02 5
65	10 <b>6 + 4</b>	6 35 02 134 03 0

### E-CUT precision saw blade

Maximum cutting speed and precision thanks to double-row Japan teeth. For wood up to 50 mm, plasterboard and soft plastics.

Length 50 mm, form 126



Width mm	Savings Qty pack	Order number
35	1	6 35 02 126 01 3
35	3 <b>2 + 1</b>	6 35 02 126 03 0
35	10 <b>6 + 4</b>	6 35 02 126 04 0

Length 50 mm, form 127



Width mm	Savings Qty pack	Order number
65	1	6 35 02 127 01 7
65	3 <b>2 + 1</b>	6 35 02 127 02 0
65	10 <b>6 + 4</b>	6 35 02 127 03 0

### E-CUT universal saw blade

Wide range of applications thanks to bi-metal teeth. Saws wood up to 50 mm, plastics, sheet metal up to 2 mm, copper or aluminium pipes and profiles.

Length 60 mm, form 151



Width mm	Savings Qty pack	Order number
29	1	6 35 02 151 01 8
29	3 <b>2 + 1</b>	6 35 02 151 02 0
29	10 <b>6 + 4</b>	6 35 02 151 03 0

Length 60 mm, form 152



Width mm	Savings Qty pack	Order number
44	1	6 35 02 152 01 0
44	3 <b>2 + 1</b>	6 35 02 152 02 0
44	10 <b>6 + 4</b>	6 35 02 152 03 0

### E-CUT-saw blade multi-pack

Consisting of 3 different E-CUT saw blades: 1 x E-CUT precision 65 mm wide, 1 x E-CUT standard 35 mm wide, 1 x E-CUT universal 44 mm wide. This way, you're perfectly equipped for any sawing job.



Order number	6 35 02 127 04 0
--------------	------------------

### HSS saw blade for wood

Round HSS saw blade for wood – the “mini circular saw” is ideal for long, straight cuts and for making cut-outs in laid parquet, laminate and wall panelling.



Ø mm	Order number
100	6 35 02 154 01 0

As set version, incl. depth stop

Ø mm	Order number
100	3 26 07 065 02 0

### Contact guard

Spare contact guard for HSS saw blade 6 35 02 154 01 0.

Order number	3 18 10 263 00 0
--------------	------------------

### Depth stop

Suitable for all E-CUT saw blades and the HSS saw blade for wood. Only suitable for the new FEIN MULTIMASTER FMM 250/250 Q.



Order number	3 26 07 065 01 0
--------------	------------------

**M-CUT saw blade**

For cut-outs in fibreglass, CFRP, wood and sheet metal, from edge length of 10 mm, max. cutting depth: 45 mm (fibreglass, wood), in sheet metal approx. 1 mm, length 50 mm



Width mm	Qty	Order number
10	2	6 35 02 159 01 0

For cut-outs in fibreglass, CFRP, wood and sheet metal, from edge length of 30 mm, max. cutting depth: 45 mm (fibreglass, wood), in sheet metal approx. 1 mm, length 50 mm



Width mm	Qty	Order number
30	2	6 35 02 157 01 0

**Carbide file**

For deburring and filing cut-outs in fibreglass, CFRP, plastics and wood, length 50 mm



Width mm	Qty	Order number
10	2	6 37 06 017 01 0

**Saw and file set**

Saw and file set for making recesses in fibreglass, CFRP, wood and sheet metal. M-CUT saw blade 10 mm and 30 mm, carbide file 10 mm



Order number	6 35 02 157 02 0
--------------	------------------

**MINICUT and file set**

For cut-outs from 10 mm. 2 saw blades for wood and soft plastics, 2 HSS saw blades for hard plastics, fibreglass and sheet metal up to 1 mm, 1 diamond file insert, 1 carbide file insert.



Order number	6 39 01 025 06 0
--------------	------------------

**MINICUT saw blade**

For wood and other soft materials, immersion depth 30 mm.



Width mm	Qty	Order number
10	2	6 35 02 132 01 3
20	2	6 35 02 131 01 0

**MINICUT HSS saw blade**

For non-ferrous metals and plastics, immersion depth 20 mm.



Width mm	Qty	Order number
10	2	6 35 02 130 01 1
20	2	6 35 02 129 01 9

**Diamond file insert**

For sharpening blades and cutters



Width mm	Grit	Order number
10	Extra fine	6 37 06 014 02 6
20	Fine	6 37 06 013 02 8
20	Normal	6 37 06 012 02 4

**Carbide file insert**

For filing cut-outs and for deburring work. Suitable for MINICUT and file set.



Order number	6 37 06 015 01 0
--------------	------------------

**Rasping**

**Carbide rasp, triangular**

Carbide-tipped  
For coarse sanding of fillers, tile adhesives, concrete, stone and wood. Suited to use with or without dust extraction.



Order number	6 37 31 001 01 4
--------------	------------------

**Carbide rasp, finger-shaped**

For coarse sanding of fillers, tile adhesives, concrete, stone and wood. The finger-shaped version, which is coated on both sides, is particularly well suited to artistic work.



Order number	6 37 31 002 01 7
--------------	------------------

**Removing joints**

**Carbide segment saw blade**

For removing damaged tile joints and for milling grooves in plaster, porous concrete and similar construction materials. Cutting width approx. 2.2 mm.



Ø mm	Order number
63	6 35 02 118 01 6

**Carbide saw blade**

Extra thin version for very narrow tile joints and for reworking deck joints. Cutting width approx. 1.3 mm.



Ø mm	Order number
63	6 35 02 125 01 0

**Diamond saw blade**

For cutting out marble and concrete trass joints. Produces minimal dust levels, very long service life. Cutting width approx. 2.2 mm.



Ø mm	Savings		Order number
	Qty	pack	
63	1		6 35 02 105 01 2
63	5	4 + 1	6 35 02 105 02 0

**Diamond segment saw blade**

For removing damaged tile joints and for milling grooves in plaster, porous concrete and similar construction materials. Long service life. Cutting width approx. 2.2 mm.



Ø mm	Savings		Order number
	Qty	pack	
63	1		6 35 02 114 01 7
63	5	4 + 1	6 35 02 114 02 0

**Cleaning block**

Rhombus for cleaning carbide and diamond tools.



Order number	6 37 19 007 01 0
--------------	------------------

**Scraping**

**Rigid stopper knife**

For removing stubborn old paint, adhesive residues, carpets, tile adhesives and coats of underseal.



Order number	6 39 03 178 01 7
--------------	------------------

**Flexible stopper knife**

For removing silicone or acrylic joints in bathrooms and labels.



Qty	Order number
2	6 39 03 165 01 3

**Sanding**

**Sanding pad set, unperforated**

For sanding without dust extraction.



Qty	Order number
2	6 38 06 129 02 6

**Sanding pad set, plastic**

With plastic backing plate to avoid marks.



Qty	Order number
2	6 38 06 153 02 2

**Sanding pad set, flat**

For very narrow openings (e.g. slats on cupboards, window shutters).



Qty	Order number
2	6 38 06 142 02 9

## ACCESSORIES

### Sanding sheet set

For universal use on practically all surfaces. High sanding capacity guaranteed thanks to corundum sanding grits and full bonding with artificial resins. Sanding sheets, unperforated, with hook and loop fastening, 10 of each grit (60, 80, 120, 180, 240).



Order number 6 37 17 082 03 3

### Sanding sheets

Unperforated, with hook and loop fastening. For universal use on practically all surfaces.



Grit	Qty	Order number
36	5	6 37 17 086 04 8
40	5	6 37 17 081 04 6
60	5	6 37 17 082 04 9
80	5	6 37 17 083 04 3
100	5	6 37 17 084 04 1
120	5	6 37 17 085 04 5
150	5	6 37 17 087 04 2
180	5	6 37 17 088 04 0
220	5	6 37 17 089 04 4
240	5	6 37 17 090 04 6

36	50	6 37 17 086 01 0
40	50	6 37 17 081 01 8
60	50	6 37 17 082 01 1
80	50	6 37 17 083 01 5
100	50	6 37 17 084 01 3
120	50	6 37 17 085 01 7
150	50	6 37 17 087 01 4
180	50	6 37 17 088 01 2
220	50	6 37 17 089 01 6
240	50	6 37 17 090 01 8

### Sanding pad, super-soft

For special areas of application such as aluminium rims and paint repairs. Only use with "Sanding sheets, super-soft".



Qty Order number  
2 6 38 06 141 02 6

### Sanding sheets, super-soft

Special sanding sheets for working on aluminium rims, performing touch-up work for dust inclusions, dealing with paint runs, overspray on wood, plastic, metal etc. Can only be used in conjunction with sanding pad 6 38 06 141 02 6.



Grit	Qty	Order number
240	50	6 37 17 126 01 5
320	50	6 37 17 127 01 9
400	50	6 37 17 128 01 7
500	50	6 37 17 179 01 6

### Profile sanding set

Consisting of 1 holder and 6 different profile inserts: 1 x V-shaped for 90° angle, 1 x trapezoid-shaped for tongue-and-groove connections, 1 x for straight profiles, 1 x convex form (large), 1 x concave and 1 x convex form (small) and sanding sheets, 5 of each grit (80, 120 and 180).



Order number 6 38 06 183 01 3

### Sandpaper for profile sanding set

For practically all materials, e.g. wood, metal, paint and plastics.



Grit	Qty	Order number
80	25	6 37 17 217 01 6
120	25	6 37 17 218 01 4
180	25	6 37 17 219 01 8

### Sanding set, stone

Can be universally used for working with stone and stone products. Consisting of: sanding sheets, 5 of each, unperforated. Grit 40, 80, 120, 220, 320, 400, 600, 800, sanding pad, 1 of each, unperforated, with aluminium and plastic backing plate, 1 felt polishing pad.



Order number 6 38 06 129 06 7

### Sanding sheets, stone

Specially for working with natural and artificial stone. In 8 stages for coarse and fine sanding.



Grit	Qty	Order number
40	50	6 37 17 120 01 4
80	50	6 37 17 121 01 3
120	50	6 37 17 122 01 6
220	50	6 37 17 123 01 0
320	50	6 37 17 124 01 8
400	50	6 37 17 125 01 2
600	50	6 37 17 175 01 7
800	50	6 37 17 176 01 0

### Sanding finger

For use in very narrow and deep places, in channels, grooves, openings and folds. Also in mould-making, on concave forms and in convex forms.



Height mm Qty Order number  
7 2 6 38 06 159 02 3

### Sanding sheets for sanding finger

With hook and loop fastening, fully bonded with artificial resins, high sanding capacity, corundum. Area of application: wood, metal, soldered joints, fibreglass, plastic, paint, filler and leather.



Grit	Qty	Order number
40	20	6 37 17 184 01 2
60	20	6 37 17 185 01 6
80	20	6 37 17 186 01 9
100	20	6 37 17 187 01 3
120	20	6 37 17 188 01 1
150	20	6 37 17 189 01 5
180	20	6 37 17 190 01 7
220	20	6 37 17 191 01 6
240	20	6 37 17 192 01 9

### Sanding pad set, perforated

For sanding with dust extraction.



Qty Order number  
2 6 38 06 136 02 9

### Sanding sheets, perforated

For sanding with dust extraction. For universal use on practically all surfaces. High sanding capacity guaranteed thanks to corundum sanding grits and full bonding with artificial resins. From grit 36 to 280.



Grit	Qty	Order number
36	5	6 37 17 107 04 9
40	5	6 37 17 108 04 7
60	5	6 37 17 109 04 1
80	5	6 37 17 110 04 3
100	5	6 37 17 111 04 2
120	5	6 37 17 112 04 5
150	5	6 37 17 113 04 9
180	5	6 37 17 114 04 7
220	5	6 37 17 115 04 1
240	5	6 37 17 116 04 4

36	50	6 37 17 107 01 1
40	50	6 37 17 108 01 9
60	50	6 37 17 109 01 3
80	50	6 37 17 110 01 5
100	50	6 37 17 111 01 4
120	50	6 37 17 112 01 7
150	50	6 37 17 113 01 1
180	50	6 37 17 114 01 9
220	50	6 37 17 115 01 3
240	50	6 37 17 116 01 6

### Sanding sheet set

Sanding sheets, 10 of each, perforated, with hook and loop fastening, corundum, grit 60, 80, 120, 180, 240.



Order number 6 37 17 109 03 5

### Backing pad set

For fast and cost-effective sanding of medium-sized surfaces, incl. 1 backing pad with a Ø of 115 mm, perforated. Sanding sheets, 2 of each, perforated, with hook and loop fastening, grit 60, 80, 180.



Ø mm Order number  
115 6 38 06 195 02 0

### Sanding sheet set

Sanding sheets, 4 of each, with a Ø of 115 mm, perforated, with hook and loop fastening, fully bonded with artificial resins for high sanding capacity, grit 60, 80, 120, 180.



Order number 6 37 17 227 01 0

### Sanding sheets

Perforated, with hook and loop fastening, fully bonded with artificial resins for high sanding capacity.



Grit	Qty	Order number
40	16	6 37 17 230 02 0
60	16	6 37 17 227 02 0
80	16	6 37 17 228 02 0
120	16	6 37 17 229 01 0
180	16	6 37 17 231 02 0
240	16	6 37 17 232 01 0

**Polishing**

**Felt polishing pad set**

For polishing up metal parts, and for polishing and decorative polishing of stone and stone products. Can also be used to work with gelcoats on boats.



Qty	Order number
2	6 38 06 140 02 7

Material-related polishing paste can be bought from qualified specialist dealers.

**Felt polishing pad**

Felt polishing pad for polishing boat decks (gelcoat), chrome, stainless steel, aluminium, non-ferrous metals.



Qty	Order number
5	6 37 23 032 01 0

**Cleaning bristle fleece**

Bristle fleece for cleaning boat decks or cleaning / polishing anti-slip structures.



Qty	Order number
2	6 37 23 031 01 0

**All-purpose yacht cleaner**

Cleans boat hulls and decks. Also suitable for aluminium, glass, plastics and textiles.



ml	Order number
500	6 37 26 021 01 0

**Yacht polish**

Easy to use, achieves brilliant shine: for fibreglass / gelcoat and painted yachts – optimum results even with dark colours.

ml	Order number
500	6 37 26 020 01 0

**Carnauba wax + cleaner**

High-gloss seal with long-lasting effect: antistatic, impact-resistant, shampoo-resistant. Protects your yacht like a second skin.

ml	Order number
500	6 37 26 023 01 0

**Nano wax + cleaner**

Hard-wearing long-term seal: antistatic, impact-resistant, shampoo-resistant. Very fine due to nanoparticles, fills in scratches, protects from the weather and UV rays.

ml	Order number
500	6 37 26 024 01 0

**Cutting**

**Segment blade, concave**

For cutting soft materials e.g. felt, leather, polystyrene.



Order number	6 39 03 193 01 8
--------------	------------------

**Segment blade, convex**

For cutting rigid materials, e.g. floor panels made of plastic, linoleum, rubber, cardboard, leather, wire mesh, loop-pile carpet/carpet and much more.



Order number	6 39 03 192 01 4
--------------	------------------

**Cutter blade**

For cutting out panelled deck joint materials safely and at speed. Also for problem areas such as cabins, rails, gunwales, cleats and curves.



Blade width mm	Order number
3	6 39 03 200 01 7
4	6 39 03 201 01 6
5	6 39 03 202 01 9

**Dust extraction**

**Extraction set**

2 sanding pads, perforated; sanding sheets, 5 of each, perforated, grit 60, 80, 120; 1 extractor hood with suction pipe; 2 hose sockets for hose connection with a Ø of 27 and 32 mm and 2 adapter for connecting to the most common household vacuum cleaners. For FEIN MULTIMASTER.



Order number	9 26 02 081 01 0
--------------	------------------

**Adapter hose**

For connecting the dust extraction device to the most common household vacuum cleaners. Hose connection Ø 27 mm.



Version	Order number
Thin	3 06 05 110 00 8
Thick	3 06 05 109 00 6

**FEIN "DUSTEX" dust extractor**

Powerful wet and dry extractor for connecting to power tools when working in the workshop and for assembly work.

- ▶ Automatic start/stop for connecting power tools up to a maximum of 2000 W
- ▶ Large range thanks to 6 m power cable and 5 m suction hose
- ▶ Soft start function for smooth operation on the construction site
- ▶ Wet and dry operation
- ▶ Suction control
- ▶ Extensive scope of supply for universal use
- ▶ The ideal addition to the FEIN MULTIMASTER

Power consumption	W	1300
Air flow rate	l/min	3300
Max. vacuum	mbar	230
Container volume	l	24
Max. connected rating	W	2000
Weight	kg	7
Cable with plug	m	6



Included in price: 1 5 m suction hose, Ø 36 mm, 1 floor nozzle, 2 extension tubes, 1 crevice nozzle, 1 upholstery nozzle, 1 connecting piece, 1 universal connecting piece, 1 filter bag

Order number	9 20 22
--------------	---------

**Filter bag**

Standard version, pack of 5



Order number	3 13 22 781 01 7
--------------	------------------

Extra fine version for higher levels of material separation, pack of 5

Order number	3 13 22 757 01 6
--------------	------------------

**Textile long-life filter**

For cost-effective use of the dust extractor. Long service life, replaces filter bag and filter cartridge.

Order number	3 13 22 812 00 0
--------------	------------------

**General accessories**

**Table and drill jig holder**

Perfect for precision cut-outs. The FEIN MULTIMASTER can be clamped to a table or workbench and the workpiece can be guided safely to the tool. It is also possible to clamp the tool in standard drill jigs with a 43 mm collar diameter – the FEIN MULTIMASTER can be delivered via the mechanism with millimetre precision. Only suitable for FEIN MULTIMASTER FMM 250/250 Q



Order number	9 26 02 083 01 0
--------------	------------------

**System case, empty**

Plastic case with practical inner layout, contains no tools or accessories.



Order number	3 39 01 118 03 0
--------------	------------------

**System case, filled**

Filled plastic case with 1 sanding pad, perforated, for dust extraction, sanding sheets, 5 of each, perforated, grit 60, 80, 120, 180, 1 dust extraction device, 2 hose sockets for suction hose with a Ø of 27/32 mm and 2 adapters for connection to the most common household vacuum cleaners, profile sanding set, 1 carbide rasp.



Order number	3 39 01 118 17 0
--------------	------------------

**FEIN. Unverwüstliche  
Elektrowerkzeuge.**



## **FEIN – professional quality from the inventor of the power tool.**

FEIN is the specialist for professional and extremely reliable power tools and special application solutions in metalworking, interior fitting and the automotive sector. As the inventor of the electric hand drill, FEIN has been developing innovative and unbeatably efficient solutions for everyday use which can also stand up to the toughest continuous use in industry and trade for over 140 years.



### **Make the most of the 3-year FEIN PLUS warranty**

We offer the 3-year FEIN PLUS warranty for all your FEIN power tools. All you need to do is register your new FEIN power tool at [www.fein.com](http://www.fein.com) within 6 weeks of purchase.

### **Your specialist dealer will be happy to help:**

**Germany:** C. & E. FEIN GmbH, Hans-Fein-Str. 81, 73529 Schwäbisch Gmünd-Bargau

**Great Britain:** FEIN Industrial Power Tools UK Ltd., 4 Badby Park, Heartlands Business Park, Daventry, Northants NN11 8YT, Phone 01327 308730

**USA:** FEIN Power Tools Inc., 1030 Alcon Street, Pittsburgh, PA 15220, Phone 1-412-922-8886, Toll Free: 1-800-441-9878

**Canada:** FEIN Canadian Power Tool Company, 323 Traders Blvd. East, Mississauga, Ontario L4Z 2E5, Phone 905 890-1390, Toll Free: 1-800-265-2581  
FEIN Quebec Ltee, 2810 De Miniac, St. Laurent, Quebec H4S 1K9, Phone 514 331-7390, Toll Free: 1-800-789-8181

[www.fein.com](http://www.fein.com)

**Australia:** FEIN Power Tools Pty. Ltd., Unit 7/55 – 61 Pine Road, Yennora N.S.W. 2161; P.O. Box 328, Fairfield N.S.W. 1860, Phone 1300 798 688

**India:** FEIN Power Tools India Pvt. Ltd., 69 Arcot Road, Kodambakkam, Chennai - 600 024, Phone 044-43 578 680, Fax 044-24837788

**Regional Office of Asia Pacific:** FEIN Power Tools Asia Limited, A1, 11/F, Block A, Mai Hing Industrial Building, 16-18 Hing Yip Street, Kwun Tong, Kowloon, Hong Kong, Phone +852 2341-1026, Fax +852 2341-2250

**Turkey:** Özensan Sanayi Makina ve Malzemeleri Anonim Şirketi, Tünel Cad. Medrese sok. No.12/A, 34420 Karaköy - İstanbul, Telefon 0212- 244 13 50 / 249 79 12, Fax 0212- 245 25 69

**Cyprus:** A. EPIPHANIOU INDUSTRIES LTD, ΒΙ. ΠΕ. Αγίου Αθανασίου, 4001 Λεμεσός, Τηλέφωνο 2581 1144, Φαξ 2572 0021